



► FROM PENTAIR WATER SOLUTIONS

EZ-RO™ 375/35L-BL RVP EU BLENDED REVERSE OSMOSIS SYSTEM

System Part Number: EV9975-92E



EZ-RO 375/35L-BL wall mount



EZ-RO 375/35L-BL with optional floor stand bracket



35L (5-gallon) hydropneumatic tank

SYSTEM DESCRIPTION

Leveraging proprietary technology, the EZ-RO 375/35L BL system uses Reverse Osmosis (RO) to reduce Total Dissolved Solids (TDS); it provides up to 1'419 L/day (375 gal/day)* and includes a 35-liter hydropneumatic tank. Blending and remineralization allow you to control TDS for optimal espresso, coffee and tea*.

APPLICATIONS

- ◆ Espresso
- ◆ Coffee
- ◆ Tea / iced tea
- ◆ Ice

FEATURES • BENEFITS

- ◆ Meets espresso, coffee, and tea equipment and customer water quality standards; known to significantly reduce scale and corrosion problems due to high TDS, water hardness*, and chlorides†
- ◆ Precision stainless steel blend valve and built-in TDS meter allow customized TDS for optimum extraction and taste profile for espresso, coffee and tea*
- ◆ 4CM cartridge provides calcium and magnesium for improved extraction
- ◆ Sealed hydropneumatic storage tank provides capacity and pressurized water to downstream equipment
- ◆ Compact design allows installation under counters and in tight spaces
- ◆ Prefiltration with 4CB5-S reduces chlorine and extra fine dirt and particles as small as five (5) microns in size by mechanical means to help protect the RO membrane
- ◆ Pressure gauge allows monitoring of RO inlet pressure and prefilter condition
- ◆ Built-in bypass, sample port and flush valves speed up installation and cartridge replacement
- ◆ High flow 1/2" OD tubing optimized water line to equipment
- ◆ Installation kit comes complete with tubing, fittings, and mounting hardware for installation; color coded parts and color photographs in manual makes installation easy
- ◆ High efficiency RO membrane saves up to two times more water than standard RO membranes‡
- ◆ Rotary vane pump driven by a 24VDC motor, featuring self priming and internal relief valve, ensures quiet operation, pulsation-free flow and a long service life

INSTALLATION TIPS

- ◆ Feed water connection to system—should be COLD only. Tempered water up to 80°F (26.6°C) can be used.
- ◆ Do not exceed system specifications for temperature and pressure.
- ◆ Provide a dedicated feed water supply connection of at least 3/8" inner diameter.
- ◆ Allow 3" clearance below system for filter cartridge removal and replacement.
- ◆ Detailed, illustrated installation guide is included with each system.

*Not performance tested or certified by NSF.

† When installed, serviced and maintained according to Pentair Everpure Installation Operation Instructions.

‡ Up to 50% recovery compared to standard RO systems with 25% recovery.

EPA Est. 002623-IL-003

EZ-RO™ 375/35L-BL RVP EU BLENDED REVERSE OSMOSIS SYSTEM

EV9975-92E

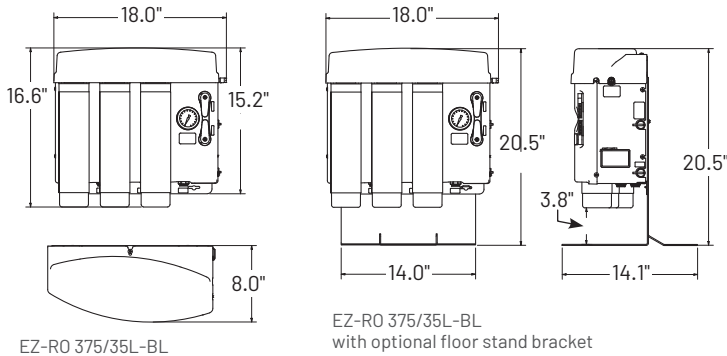

EZ-RO 375/35L-BL

EZ-RO 375/35L-BL with optional floor stand bracket

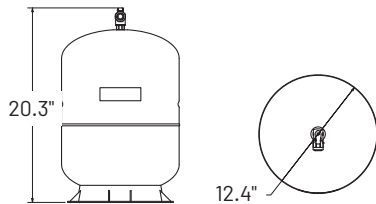

35L (5-gallon) hydropneumatic tank

SPECIFICATIONS

System	System
Overall Dimensions - Processor 16.6" H x 18.0" W x 8.0" D (42.2 cm x 45.7 cm x 20.3 cm)	Shipping Weight 40.5 lbs (18.4 kgs)
Tank Dimensions & Capacity 20.3" H x 12.4" DIA (51.6 cm x 31.5 cm) 5 gallons (18.9 L)	Electrical Connection Schuko CEE 7/7 Plug UK BS1363A Plug
Connections Inlet: 3/8" push-to-connect Outlet: 1/2" OD push-to-connect	Performance
Pressure Requirements 50 - 100 psi (3.5 - 6.9 bar), non-shock	Daily Production Rate Up to 375 gal/day (1,419 L/day)* nominal at 77°F (25°C), 60 psi (4.1 bar) feed water pressure*; production will vary based on water supply temperature and pressure
Water Temperature 40-100°F (4 - 38°C)	Service Flow Rate Dependent on water level and pressure in storage tank.

*Not performance tested or certified by NSF.

OPTIONS

Model	Description	Part No
PRV	Pressure reducing valve	164-89938
Air Gap Kit	Air gap approved for drain	164-89905
EZFS	Floor stand bracket	EV3159-68
Mixing Valve	Thermostatic mixing valve	EV3114-79

REPLACEMENT CARTRIDGES

Model	Qty	Description	Part No
4CB5-S	1	Prefilter	EV9617-21
EZ-375	1	RO membrane	EV9628-93
4CM	1	Mineral addition	EV9627-80

It is recommended that pre-/post-filters and mineral addition cartridges are changed every six (6) months, when capacity is reached, or when feed water pressure or flow becomes inadequate.

The contaminants or other substances removed or reduced by this drinking water system are not necessarily in your water. Do not use with water that is microbiologically unsafe or of unknown quality without adequate disinfection before or after the system.

Since the conditions under which our products may be used are beyond our control, we cannot accept any liability with respect to the improper installation, application and/or use of our products.

For Pentair Patent Information visit:
<http://pentair.com/patents>



United States | 1040 Muirfield Drive | Hanover Park, IL 60133 | 800.942.1153 (US Only) 630.307.3000 Main | cseverpure@pentair.com | foodservice.pentair.com
Australia | 1-21 Monash Drive | Dandenong South, Vic 3175 | Australia | 011.1300 576 190 Tel | au.everpure@pentair.com
China | 21F Cloud 9 Plaza, NO 1118 | Shanghai, 200052 | China | 86.21.3211.4588 Tel | china.water@pentair.com
India | Boulevard, B-9/A, 7th Floor - Tower B Sector 62 | Noida - 201301 | 91.120.419.9444 Tel | indiacustomer@pentair.com
Europe | Pentair Water Belgium BV | Industriepark Wolfstee, Toekomstlaan 30, B-2200 Herentals | Belgium | +32.(0).14.283.504 Tel | foodservice.eu@pentair.com
Japan | Japan Inc. | Hashimoto MN Bldg. 7F, | 3-25-1 Hashimoto, Midori-ku, Sagami-hara-shi | Kanagawa 252-0143 | Japan | 81.(0)42.775.3011 Tel | info@everpure.co.jp
Southeast Asia | 390 Havelock Road, | #04-01 King's Centre | Singapore 169662 | 65.6768.5800 Tel | cseverpure@pentair.com

All indicated Pentair trademarks and logos are property of Pentair. Third party registered and unregistered trademarks and logos are the property of their respective owners.